

Concrete: Beton : Béton : Beton :	
6X	DIN 16168 – M8x80

Wood / Concrete : Holz / Beton : Bois / Béton : Hout / Beton :	
6X	DIN 571 – M8 x 80 4.6

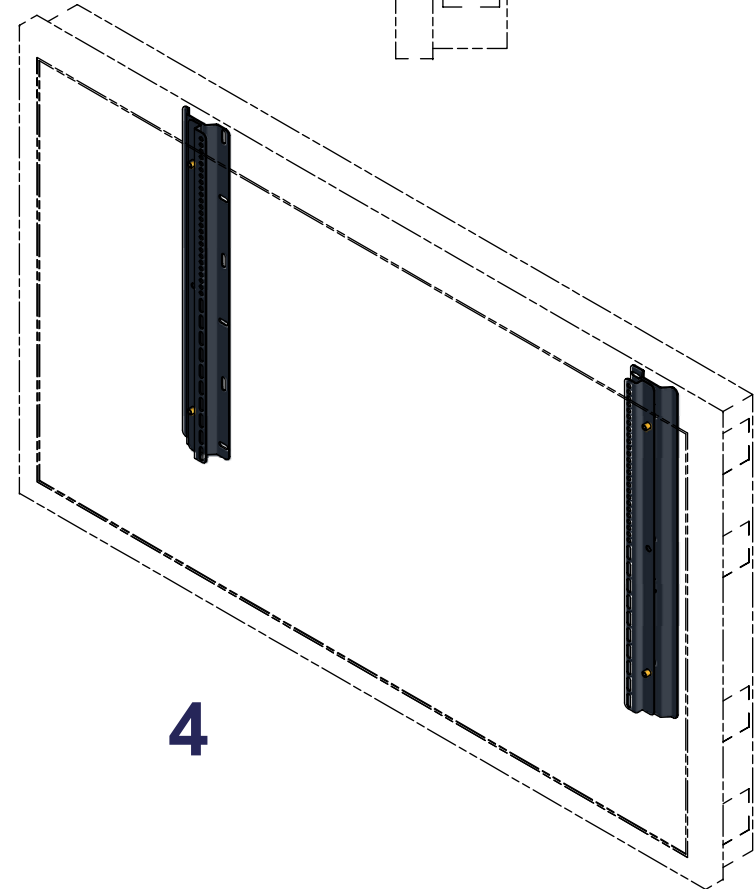
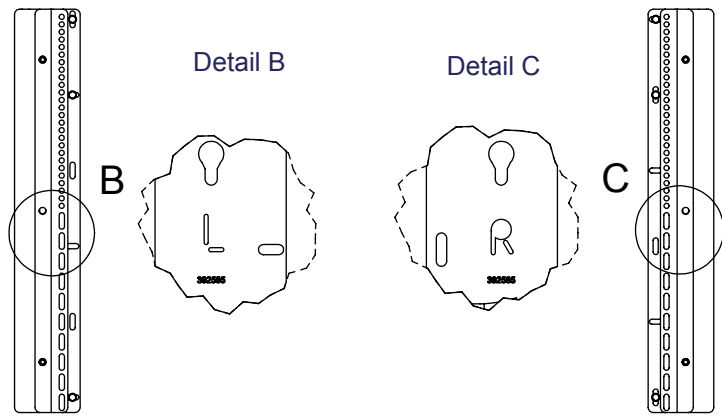
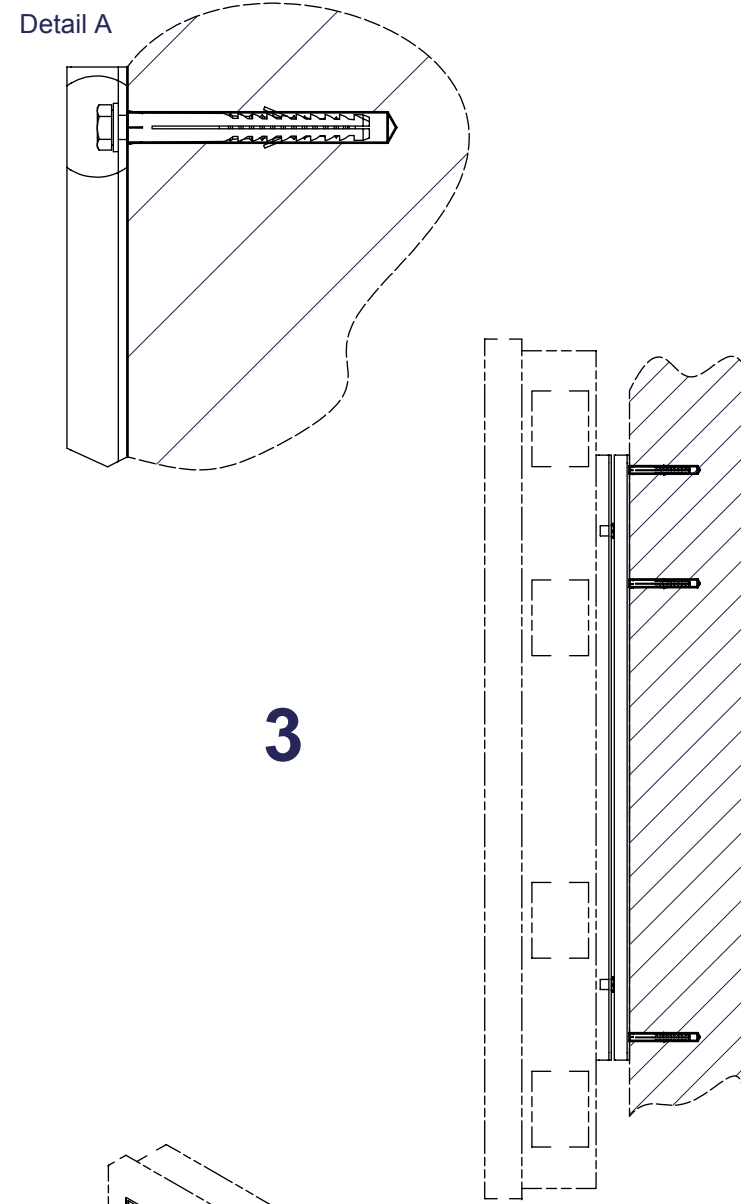
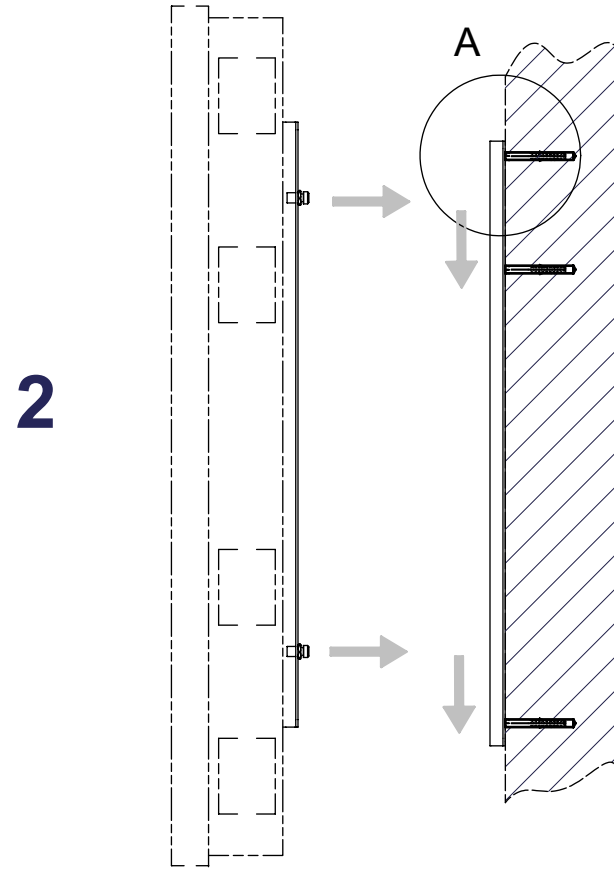
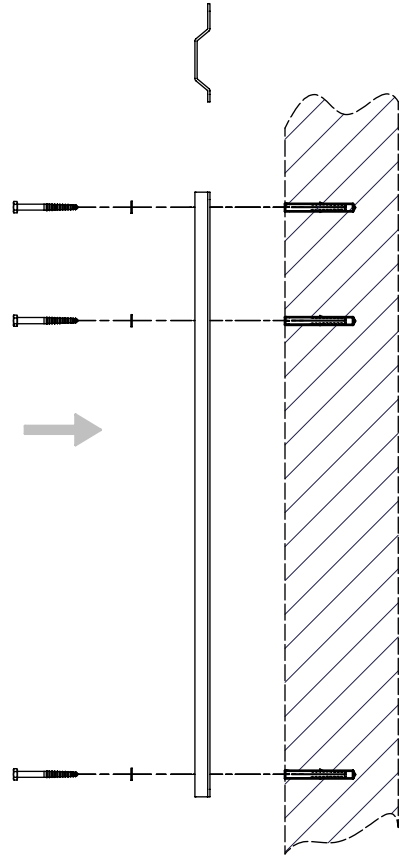
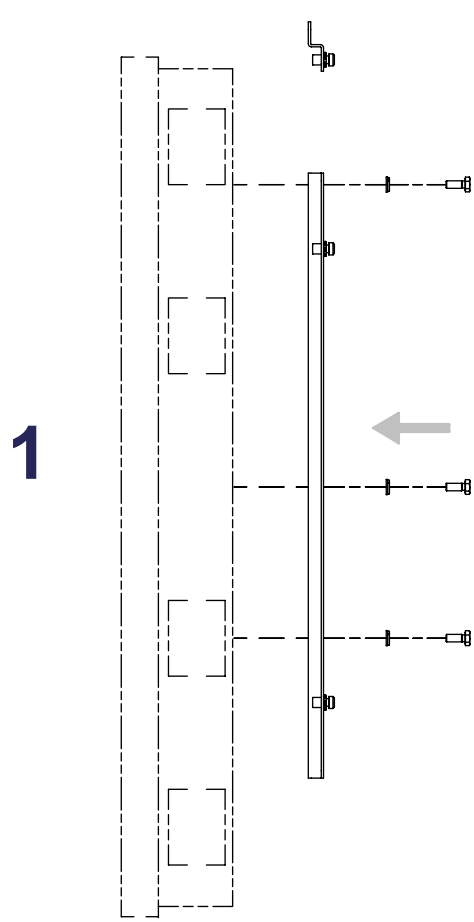
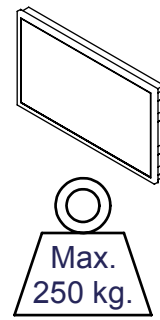
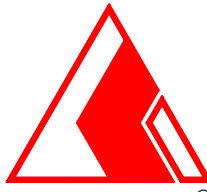

NOTE: All dimensions are ±..., in mm and subject to change

© COPYRIGHT AUDIPACK This print and the information shown thereon, is the property of AUDIPACK. It may not be delivered to others nor reproduced for general circulation without the written consent of the AUDIPACK engineering department.	 AUDIPACK [®]	AUDIPACK Industriestraat 2-4 2751 GT Moerkapelle the Netherlands Tel: +31(0)795931671 Fax: +31(0)795933115 www.audipack.com
	MOUNTING GUIDE	

392585 **LARGE SCREEN WALL MOUNT**

18-2-2009