

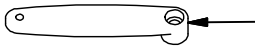

# Pakketinhoud QFIX-2

## QFIX Armen (los in zakje):

(8X)  310050  
Quatrofix arm 2010

## Onderdelen QuatroFix montage(los in zakje):

(8X)  DIN 127 - A 5 - ST 8.8  
ENKELE VEERRING GEBOGEN EIND

(4X)  DIN 125-1 - A 5,3 - ST 8.8  
VLAKKE SLUITRING VOOR ZESKANT

(4X)  DIN 912 - M5x12 - 0,8 - ST 8.8 - 10  
CYLINDERSCHROEF BINNENZESKANT

(4X)  DIN 912 - M5x16 - 0,8 - ST 8.8 - 14  
CYLINDERSCHROEF BINNENZESKANT

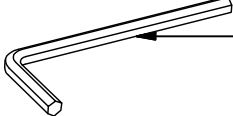
(1X)  Inbussleutel 4mm

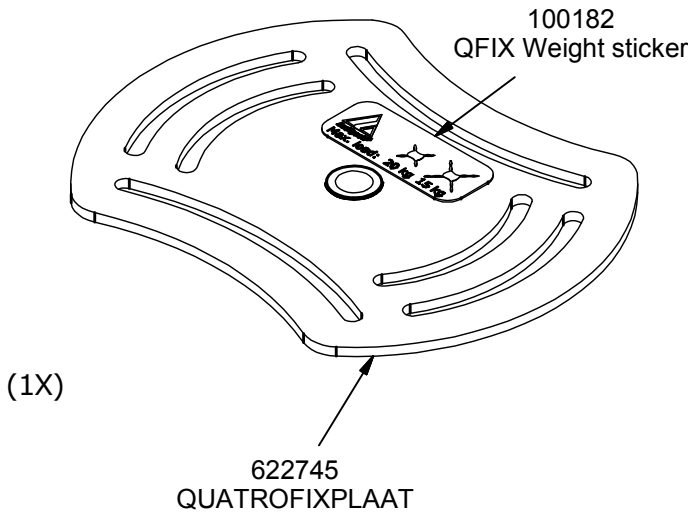



## Onderdelen Projector Montage (los in zakje):

(4X)  DIN 125-1 - A 3,2 - ST 8.8  
VLAKKE SLUITRING VOOR ZESKANT

(4X)  DIN 125-1 - A 4,3 - ST 8.8  
VLAKKE SLUITRING VOOR ZESKANT

(4X)  DIN 125-1 - A 5,3 - ST 8.8  
VLAKKE SLUITRING VOOR ZESKANT

(4X)  DIN 7985 - M3x20 - 4.8 - H - ST 8.8  
BOLCYLINDERSCHROEF KRUISGLEUF

(4X)  DIN 7985 - M3x25 - 4.8 - H - ST 8.8  
BOLCYLINDERSCHROEF KRUISGLEUF

(4X)  DIN 7985 - M4x20 - 4.8 - H - ST 8.8  
BOLCYLINDERSCHROEF KRUISGLEUF

(4X)  DIN 7985 - M4x25 - 4.8 - H - ST 8.8  
BOLCYLINDERSCHROEF KRUISGLEUF

(4X)  DIN 7985 - M5x20 - 4.8 - H - ST 8.8  
BOLCYLINDERSCHROEF KRUISGLEUF

(4X)  DIN 7985 - M5x25 - 4.8 - H - ST 8.8  
BOLCYLINDERSCHROEF KRUISGLEUF

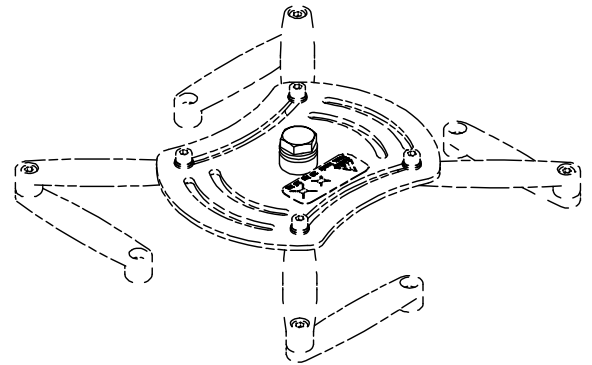

## Onderdelen QuatroFix i.c.m. OPEN AIR / Ceilinglift / Mirrorkit montage (los in zakje):

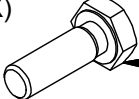
(1X)  DIN 933 - M10x30 - ST 8.8  
ZESKANTBOUT

(1X)  DIN 125-1 - A 10,5 - ST 8.8  
VLAKKE SLUITRING VOOR ZESKANT

(1X)  691619  
AFSTANDBUS

© COPYRIGHT AUDIPACK  
This print and the information shown thereon, is the property of AUDIPACK.  
It may not be delivered to others nor reproduced for general circulation without the written consent of the AUDIPACK engineering department.



**AUDIPACK**  
Industriestraat 2-4  
2751 GT Moerkapelle  
the Netherlands  
Tel: +31(0)795931671  
Fax: +31(0)795931115  
www.audipack.com

QFIX-2

Quatro-Fix Universal PROJECTOR MOUNT

14-9-2010

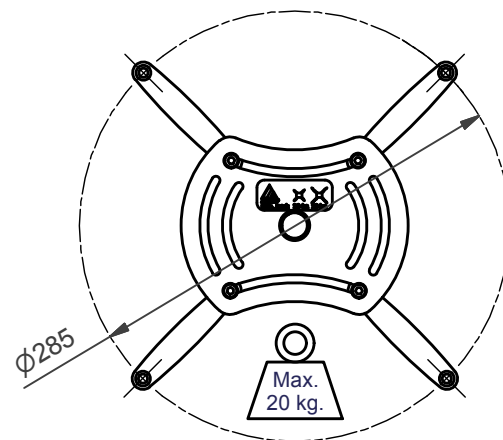
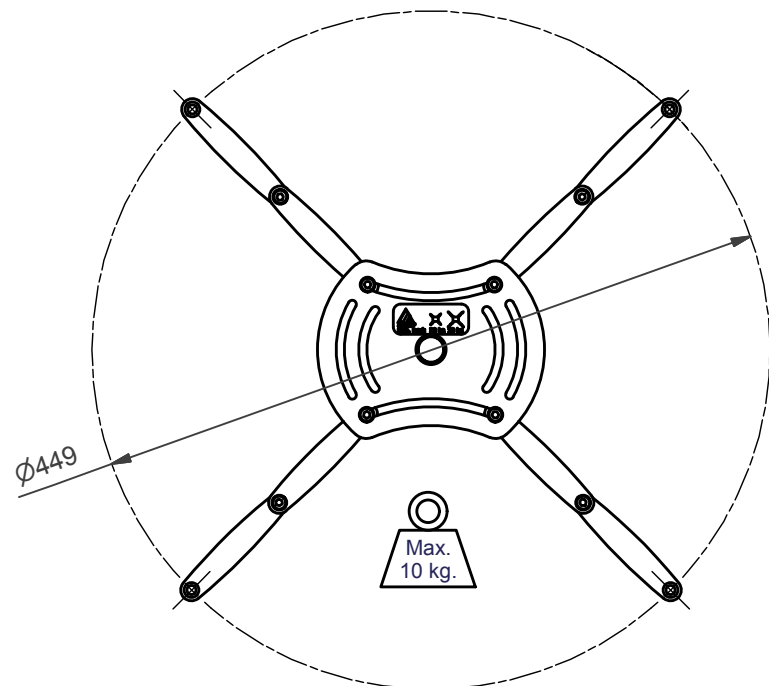
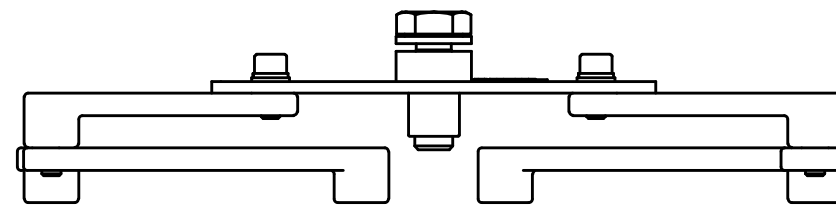
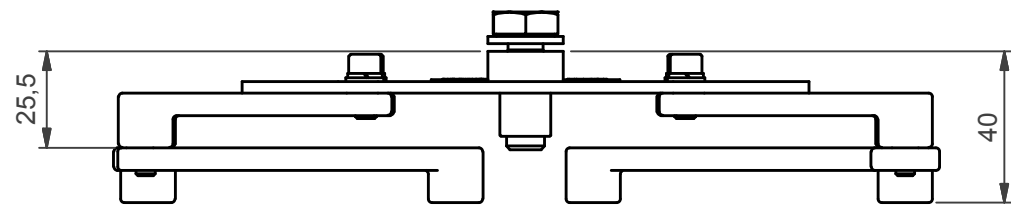
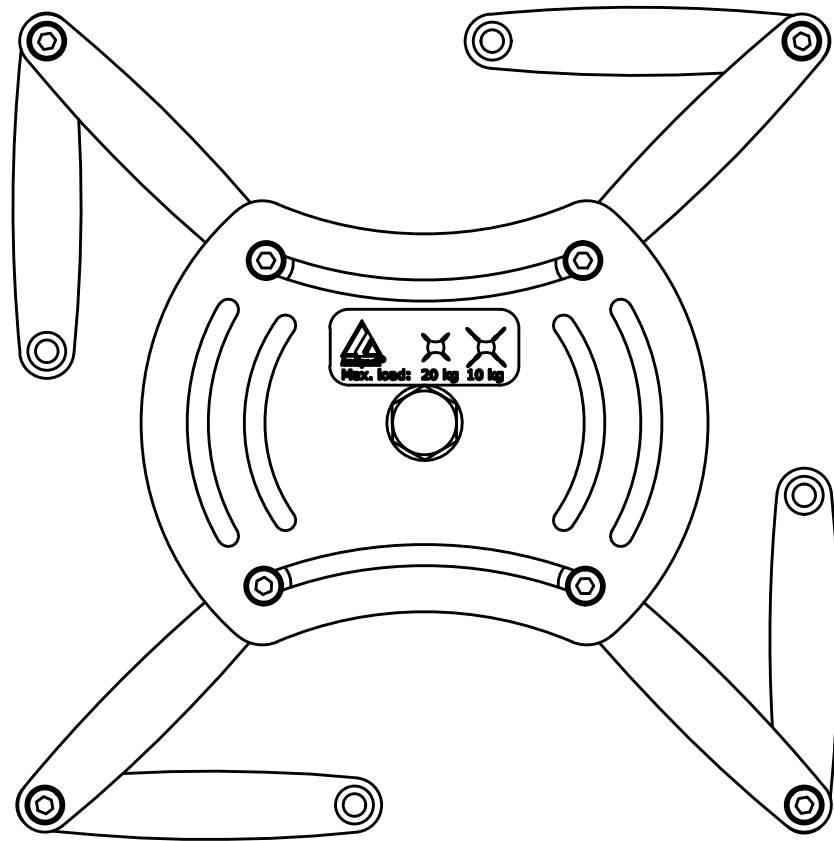

NOTE: All dimensions are ±..., in mm and subject to change

© COPYRIGHT AUDIPACK  
 This print and the information shown thereon, is the property of AUDIPACK.  
 It may not be delivered to others nor reproduced for general circulation without the written consent of the AUDIPACK engineering department.



**AUDIPACK**  
 Industriestraat 2-4  
 2751 GT Moerkapelle  
 the Netherlands  
 Tel: +31(0)795931671  
 Fax: +31(0)795933115  
 www.audipack.com

PRESENTATION

QFIX-2 Quatro-Fix Mount without ball joint

Dimensions are indications, not to be used for any preparations. No rights can be derived from the above dimensions.

30-5-2011